

**eisco**  
INDUSTRIAL

**METALWARE**





## EISCO PREMIUM METAL CLAMPS

- Research grade quality and design for industrial and academic lab
- Solid zinc die-cast construction made from Zamac 3 Alloy + aluminium alloy
- Complete non-ferrous construction, rust resistant and durable in even the toughest scientific testing environments
- Wide range of options for various laboratory applications
- High grade non-toxic powdered coating



1

### Premium Clamp - Three Prong, Vinyl Coated

- 3 prong vinyl coated clamp attached to stainless steel rod
- Clamp constructed of powder coated high grade aluminium alloy
- Maximum clamp opening is 8.5 cm
- 14 cm long, 10 mm diameter stainless steel connecting rod
- Complete metal construction, thread fitted actuating joints

Code	Specs	Price/Piece ₹
PRCMP01/SL 1	Premium Clamp - Three Prong, Vinyl Coated	<b>562.00</b>



2

### Premium Clamp - Three Prong, Vinyl Coated, with Bosshead

- 3 prong vinyl coated clamp attached to swivel bosshead
- Clamp constructed of powder coated high grade aluminium alloy
- Maximum clamp opening is 8.5 cm
- Swivel between clamp and bosshead
- High strength aluminium alloy bosshead
- Bosshead accommodates up to 18 mm rod

Code	Specs	Price/Piece ₹
PRCMP01BH/SL 2	Premium Clamp - Three Prong, Vinyl Coated, with Bosshead	<b>816.00</b>



### Premium Clamp - Four Prong, Cork Lined

- 4 prong cork lined clamp attached to stainless steel rod
- Clamp constructed of powder coated high grade aluminium alloy
- Maximum clamp opening is 10.5 cm
- 14 cm long, 10 mm diameter stainless steel connecting rod
- Complete metal construction, thread fitted actuating joints



Code	Specs	Price/Piece ₹
PRCMP02/SL 1	Premium Clamp - Four Prong, Cork Lined	542.00

### Premium Clamp - Four Prong, Cork Lined, with Bosshead

- 4 prong cork lined clamp attached to swivel bosshead
- Clamp constructed of powder coated high grade aluminium alloy
- Maximum clamp opening is 10.5 cm
- Swivel between clamp and bosshead
- High strength aluminium alloy bosshead
- Bosshead accommodates up to 18 mm rod

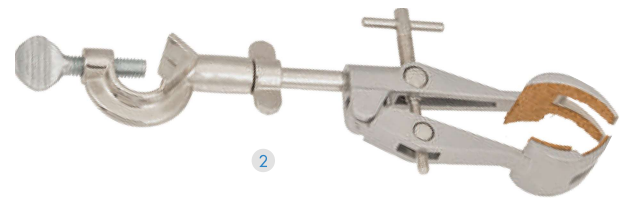

Code	Specs	Price/Piece ₹
PRCMP02BH/SL 2	Premium Clamp - Four Prong, Cork Lined, with Bosshead	762.00

### Premium Clamp - Four Prong, Vinyl Coated

- 4 prong vinyl coated clamp attached to stainless steel rod
- Clamp constructed of powder coated high grade aluminium alloy
- Maximum clamp opening is 10.5 cm
- 14 cm long, 10 mm diameter stainless steel connecting rod
- Complete metal construction, thread fitted actuating joints



Code	Specs	Price/Piece ₹
PRCMP03/SL 3	Premium Clamp - Four Prong, Vinyl Coated	648.00

### Premium Clamp - Four Prong, Vinyl Coated, with Bosshead

- 4 prong vinyl coated clamp attached to swivel bosshead
- Clamp constructed of powder coated high grade aluminium alloy
- Maximum clamp opening is 10.5 cm
- Swivel between clamp and bosshead
- High strength aluminium alloy bosshead
- Bosshead accommodates up to 18 mm rod



Code	Specs	Price/Piece ₹
PRCMP03BH/SL 4	Premium Clamp - Four Prong, Vinyl Coated, with Bosshead	868.00



### Premium Clamp - Two Prong, Vinyl Coated, Dual Adjustment

- 2 prong vinyl coated clamp attached to stainless steel rod
- Heavy duty spring loaded clamp jaw with dual screw adjustment to fine tune any fitting
- Made of zinc and powder coated alloy with all metal adjustment screws
- Maximum clamp opening is 7 cm
- 14 cm long, 10 mm diameter stainless steel connecting rod

Code	Specs	Price/Piece ₹
PRCMP04/SL 1	Premium Clamp - Two Prong, Vinyl Coated, Dual Adjustment	762.00

### Premium Clamp - Two Prong, Vinyl Coated, with Bosshead and Dual Adjustment

- 2 prong vinyl coated clamp attached to swivel bosshead
- Heavy duty spring loaded clamp jaw with dual screw adjustment to fine tune any fitting
- Clamp constructed of powder coated high grade zinc alloy with all metal screws
- Maximum clamp opening is 7 cm
- Swivel between clamp and bosshead
- High strength aluminium alloy bosshead
- Bosshead accommodates up to 18 mm rod

Code	Specs	Price/Piece ₹
PRCMP04BH/SL 2	Premium Clamp - Two Prong, Vinyl Coated, with Bosshead and Dual Adjustment	1054.00

### Premium Clamp - Two Prong, Vinyl Coated

- 2 prong vinyl coated clamp attached to stainless steel rod
- Clamp constructed of powder coated high grade zinc alloy
- Maximum clamp opening is 11 cm
- 14 cm long, 10 mm diameter steel connecting rod
- Complete metal construction, thread fitted actuating joints

Code	Specs	Price/Piece ₹
PRCMP05/SL 3	Premium Clamp - Two Prong, Vinyl Coated	583.00

### Premium Clamp - Two Prong, Vinyl Coated, with Bosshead

- 2 prong vinyl coated clamp attached to swivel bosshead
- Clamp constructed of powder coated high grade zinc alloy
- Maximum clamp opening is 11 cm
- Swivel between clamp and bosshead
- High strength aluminium alloy bosshead
- Bosshead accommodates up to 18 mm rod

Code	Specs	Price/Piece ₹
PRCMP05BH/SL 4	Premium Clamp - Two Prong, Vinyl Coated, with Bosshead	791.00





### Premium Clamp - Three Prong, Vinyl Coated, Dual Adjustment

- 3 prong vinyl coated clamp attached to stainless steel rod
- Heavy duty spring loaded clamp jaw with dual screw adjustment to fine tune any fitting
- Made of zinc and powder coated alloy with all metal adjustment screws
- Maximum clamp opening is 6 cm
- 14 cm long, 10 mm diameter stainless steel connecting rod

Code	Specs	Price/Piece ₹
PRCMP06/SL ①	Premium Clamp - Three Prong, Vinyl Coated, Dual Adjustment	762.00



### Premium Clamp - Three Prong, Vinyl Coated, with Bosshead and Dual Adjustment

- 3 prong vinyl coated clamp attached to swivel bosshead
- Heavy duty spring loaded clamp jaw with dual screw adjustment to fine tune any fitting
- Clamp constructed of powder coated high grade zinc alloy with all metal screws
- Maximum clamp opening is 6 cm
- Swivel between clamp and bosshead
- High strength aluminium alloy bosshead
- Bosshead accommodates up to 18 mm rod

Code	Specs	Price/Piece ₹
PRCMP06BH/SL ②	Premium Clamp - Three Prong, Vinyl Coated, with Bosshead and Dual Adjustment	1054.00



### Premium Clamp - Three Prong, Vinyl Coated, Dual Adjustment - Large

- 3 prong vinyl coated clamp attached to stainless steel rod
- Heavy duty spring loaded clamp jaw with dual screw adjustment to fine tune any fitting
- Made of zinc and powder coated alloy with all metal adjustment screws
- Maximum clamp opening is 9 cm
- 14 cm long, 10 mm diameter stainless steel connecting rod

Code	Specs	Price/Piece ₹
PRCMP10/SL ③	Premium Clamp - Three Prong, Vinyl Coated, Dual Adjustment - Large	852.00



### Premium Clamp - Three Prong, Vinyl Coated, with Bosshead and Dual Adjustment - Large

- 3 prong vinyl coated clamp attached to swivel bosshead
- Heavy duty spring loaded clamp jaw with dual screw adjustment to fine tune any fitting
- Clamp constructed of powder coated high grade zinc alloy with all metal screws
- Maximum clamp opening is 9 cm
- Swivel between clamp and bosshead
- High strength aluminium alloy bosshead
- Bosshead accommodates up to 18 mm rod

Code	Specs	Price/Piece ₹
PRCMP11/SL ④	Premium Clamp - Three Prong, Vinyl Coated, with Bosshead and Dual Adjustment - Large	1130.00





### Premium Clamp - Three Prong, Vinyl Coated

- 3 prong vinyl coated clamp attached to stainless steel rod
- Clamp constructed of powder coated high grade aluminium alloy
- Maximum clamp opening is 8.5 cm
- 14 cm long, 10 mm diameter steel connecting rod
- Complete metal constructions, thread fitted actuating joints



Code	Specs	Price/Piece ₹
PRCMP07/SL 1	Premium Clamp - Three Prong, Vinyl Coated	542.00

### Premium Clamp - Three Prong, Vinyl Coated, with Bosshead

- 3 prong vinyl coated clamp attached to swivel bosshead
- Clamp constructed of powder coated high grade aluminium alloy
- Maximum clamp opening is 8.5 cm
- Swivel between clamp and bosshead
- High strength aluminium alloy bosshead
- Bosshead accommodates up to 18 mm rod

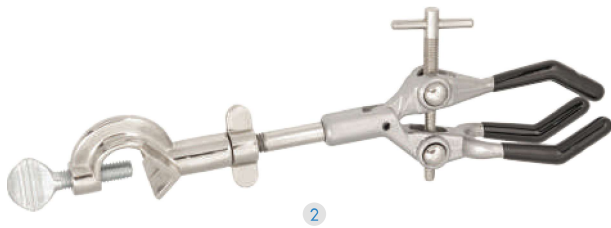

Code	Specs	Price/Piece ₹
PRCMP07BH/SL 2	Premium Clamp - Three Prong, Vinyl Coated, with Bosshead	762.00

### Premium Clamp - Two Prong, Cork Lined

- 2 prong cork lined clamp attached to stainless steel rod
- Clamp constructed of powder coated high grade zinc alloy
- Maximum clamp opening is 12 cm
- 14 cm long, 10 mm diameter steel connecting rod
- Complete metal construction, thread fitted actuating joints



Code	Specs	Price/Piece ₹
PRCMP08/SL 3	Premium Clamp - Two Prong, Cork Lined	526.00



### Premium Clamp - Two Prong, Cork Lined, with Bosshead

- 2 prong cork lined clamp attached to swivel bosshead
- Clamp constructed of powder coated high grade zinc alloy
- Maximum clamp opening is 11 cm
- Swivel between clamp and bosshead
- High strength aluminium alloy bosshead
- Bosshead accommodates up to 18 mm rod

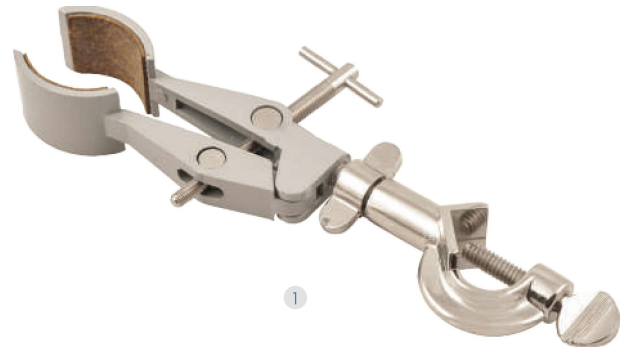

Code	Specs	Price/Piece ₹
PRCMP08BH/SL 1	Premium Clamp - Two Prong, Cork Lined, with Bosshead	762.00

### Premium Clamp - Three Prong, Cork Lined

- 3 prong cork lined clamp attached to stainless steel rod
- Clamp constructed of powder coated high grade aluminium alloy.
- Maximum clamp opening is 8.5 cm
- 14 cm long, 10 mm diameter steel connecting rod
- Complete metal construction, thread fitted actuating joints



Code	Specs	Price/Piece ₹
PRCMP09/SL 2	Premium Clamp - Three Prong, Cork Lined	542.00

### Premium Clamp - Three Prong, Cork Lined, with Bosshead

- 3 prong cork lined clamp attached to swivel bosshead
- Clamp constructed of powder coated high grade aluminium alloy
- Maximum clamp opening is 8.5 cm
- Swivel between clamp and bosshead
- High strength aluminium alloy bosshead
- Bosshead accommodates up to 18 mm rod



Code	Specs	Price/Piece ₹
PRCMP09BH/SL 3	Premium Clamp - Three Prong, Cork Lined, with Bosshead	762.00



1

### Premium Bosshead - Die Cast

- Made from high grade zinc alloy, finished in non-toxic powder coating
- Threaded metal one piece clamping screws
- Able to hold rods up to 16 mm in diameter
- Holds rods orthogonal (90 degrees) to one another
- All metal construction supports heavy loads and prevents torque damage

Code	Specs	Price/Piece ₹
PRBH01 1	Premium Bosshead - Die Cast	226.00

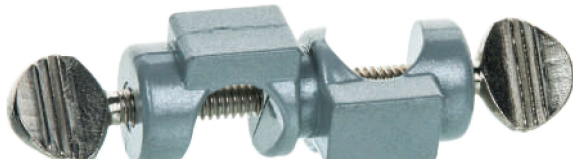

2

### Premium Bosshead - Metal

- Made from high grade zinc alloy, finished in non-toxic powder coating
- Threaded metal one piece clamping screws
- Able to hold rods up to 15 mm in diameter
- Holds rods orthogonal (90 degrees) to one another
- All metal construction supports heavy loads and prevents torque damage

Code	Specs	Price/Piece ₹
PRBH02 2	Premium Bosshead - Metal	226.00



3

### Premium Bosshead - Heavy Duty

- Made from high grade aluminium alloy, finished in non-toxic powder coating
- Thicker than normal 8 mm threaded clamping screws
- Able to hold rods up to 16 mm in diameter
- Holds rods orthogonal (90 degrees) to one another
- All metal construction with thicker casting to support more load and prevent torque damage

Code	Specs	Price/Piece ₹
PRBH03 3	Premium Bosshead - Heavy Duty	262.00



4

### Premium Bosshead - Universal Swivel

- Made from high grade zinc alloy, finished in non-toxic powder coating
- Threaded metal one piece clamping screws
- Able to hold rods up to 16 mm in diameter
- Adjusts to any angle, both bossheads can swivel 360 degrees
- All metal construction supports heavy loads and prevents torque damage

Code	Specs	Price/Piece ₹
PRBH04 4	Premium Bosshead - Universal Swivel	342.00

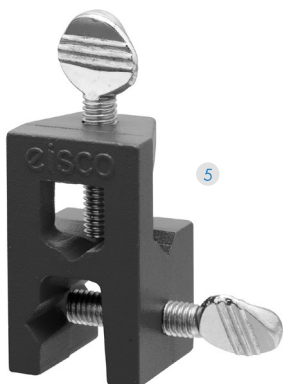

5

### Premium Bosshead - Square Head

- Made from high grade zinc alloy, finished in non-toxic powder coating
- Threaded metal one piece clamping screws
- Able to hold rods up to 15 mm in diameter
- Holds rods orthoangle (90 degrees) to one another
- All metal construction supports heavy loads and prevents torque damage

Code	Specs	Price/Piece ₹
PRBH05 5	Premium Bosshead - Square Head	354.00



### Multipurpose Clamp Holder

- Square section aluminium alloy clamp holder with metal clamping screw
- Two rectangular slots can accept square or circular rods and tubing up to 16 mm diameter
- Can also attach to table edges and boards up to 16 mm thick
- Finished in non-toxic powder coating
- All metal construction supports heavy loads and prevents torque damage

Code	Specs	Price/Piece ₹
CH0663D <sup>1</sup>	Multipurpose Clamp Holder	<b>466.00</b>

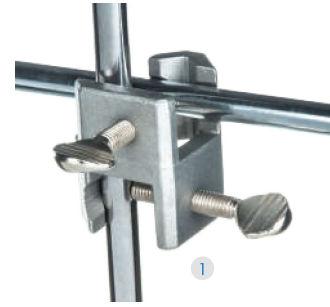

### Lattice Clamps

- For lattice building and rod coupling with 12.5 mm dia. rods
- Fitted with screws for Allen wrench
- Pack of 12

Code	Specs	Price/Pack ₹
CH0664C <sup>2</sup>	Lattice Clamps - Pack of 12	<b>2994.00</b>



### Universal Clamp Holder - Jumbo

- Made of high grade aluminium alloy, finished in non-toxic powder coated
- Threaded metal one piece clamping screws
- Accepts rods and flat boards up to 18 mm thick
- Secures onto tables up to 18 mm thick

Code	Specs	Price/Piece ₹
CH0664JM <sup>3</sup>	Universal Clamp Holder - Jumbo	<b>323.00</b>



### Double Bossheads - Large

- Die cast double bosshead, accepts rods 5 - 20 mm in diameter
- Fitted with plastic cap adjustment screws
- Thicker casting to supports more load and prevent torque damage

Code	Specs	Price/Piece ₹
CH0665A <sup>4</sup>	Bosshead - Chrome Plated	<b>690.00</b>
CH0665B <sup>5</sup>	Bosshead - Black Coated	<b>519.00</b>





### Suspension Clamps

- Use to suspend a thermometer over a hot plate
- Clamp holds items at a distance of 110 mm from the support rod
- The hook is adjustable and locks at any angle
- Accomodated rods up to 16 mm in diameter

Code	Specs	Price/Piece ₹
CH0667 1	Suspension Clamps	297.00



### Thermometer Clamp with Bosshead

- Thermometer clamp with thumbscrews and 360° jaw rotation
- Accomodates thermometers 6 to 12 mm in diameter
- Bosshead accomodates rods upto 16 mm in diameter

Code	Specs	Price/Piece ₹
CH0667A 2	Thermometer Clamp with Bosshead	379.00

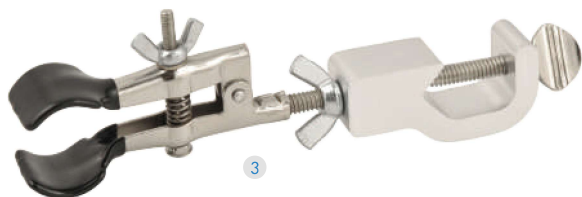

### Burette Clamp with Bosshead- PVC Coated Round Jaws

- Clamp features round PVC dipped stainless steel jaws with a 12 mm to 45 mm opening to hold burettes and test tubes
- Threaded rod and wing nut adjust clamp angle
- Overall length 13 to 15 cm
- Bosshead accomodates rods upto 16 mm in diameter

Code	Specs	Price/Piece ₹
CH0688A 3	Burette Clamp with Bosshead- PVC Coated Round Jaws	490.00

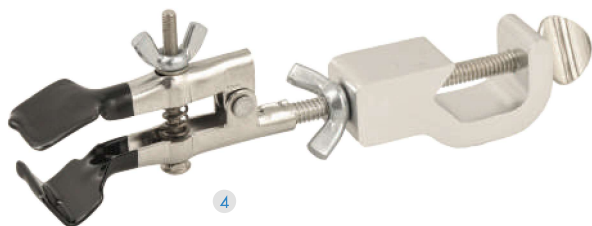

### Universal Clamp with Bosshead - PVC Coated Jaws

- Clamp features 1 flat angled and 1 'V' steel prongs dipped in PVC ensuring slip resistant grip of cylindrical objects
- Threaded rod and wing nut adjust clamp angle
- Overall length 13 to 15 cm
- Bosshead accomodates rods upto 16 mm in diameter

Code	Specs	Price/Piece ₹
CH0688B 4	Universal Clamp with Bosshead - PVC Coated Jaws	464.00

# Bunsen Burners

**eisco**  
INDUSTRIAL





### Burner Bunsen - Heavy base with Stopcock

This is similar to construction as above model but with gas control stopcock. The flow of gas can be controlled and even switched off with stopcock. Suitable for LPG / Butane gas.

Code	Specs	Price/Piece ₹
CH0086B ①	Burner Bunsen Heavy base with Stopcock	1401.00



### Burner Meker - Superior

Most popular Meker burner used for high temperature work. The top plate is made of durable ceramic. Suitable for LPG / Butane Gas. Spare nozzle supplied.

Code	Specs	Price/Piece ₹
CH0098C-LP ②	Burner Meker - Superior - LPG	2371.00



### Burner Bunsen Simple - GBR

Superior to above. Nickel plated burner tube with rotatable air regulator and cylindrical connector. Mounted on pressure die casted base. Base dia. 80 mm.

Code	Specs	Price/Piece ₹
CH0088A ③	Burner Bunsen - LPG	1344.00
CH0088B	Burner Bunsen - Natural Gas	1344.00



### Burner Bunsen with Needle Valve

Efficient and durable for general lab use. Gas flow is controlled by needle valve fitted above the base, permitting easy flame adjustment and minimizing possibility of tipping. The burner tube dia is 13 mm and mounted on pressure die casted base.

Code	Specs	Price/Piece ₹
CH0091A <sup>1</sup>	Burner Bunsen - LPG	2097.00
CH0091B	Burner Bunsen - Natural Gas	2097.00



### Burner Bunsen - Teclu

Burner giving a very hot flame, suitable for glasswork and soldering. A needle valve for fine flame adjustment is incorporated die casted base together with a tapered rifflled tube connector. A unique springoperated gas safety lock is incorporated of the air/gas mixture. For use on natural gas supplies. Base dia. 80 mm.

Code	Specs	Price/Piece ₹
CH0096-LP <sup>2</sup>	Burner Bunsen - Semi Micro - LPG	2300.00
CH0096-NG	Burner Bunsen - Semi Micro - Natural Gas	2300.00



### Mohr's Clips

- Made of nickle plated steel wire
- Maximum opening 18 mm
- Pack of 10

Code	Specs	Price/Pack ₹
CH0290A <sup>3</sup>	Mohr's Clips - Iron	587.00
CH0290B	Mohr's Clips - Brass	1479.00



### Hoffman's Clips

- Nickel plated, hinged bottom bar for direct fitting and removal without access to ends of tube
- Protecting plate to prevent damage to tubing by end of screw
- Maximum opening 15 mm

Code	Specs	Price/Piece ₹
CH0298B	Hoffman's Clips - Brass, Closed-Closed	343.00
CH0298C <sup>4</sup>	Hoffman's Clips - Brass, Open-Closed-Open	343.00
CH0298D <sup>5</sup>	Hoffman's Clips - Brass, Open-Closed	343.00

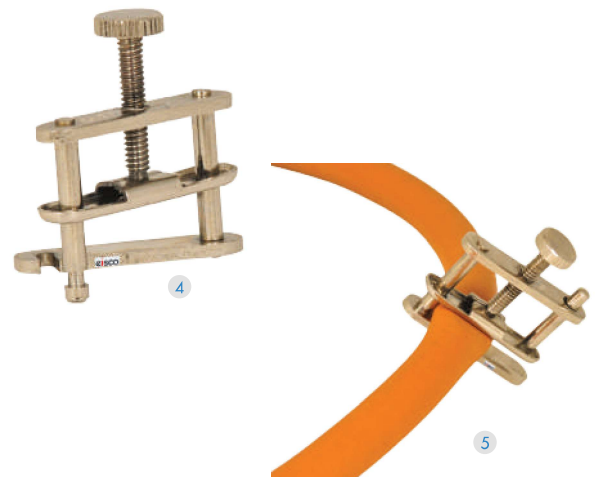



### Wire Gauze - Iron with Ceramic Center

- Square wire gauze made of iron with ceramic center
- Pack of 10

Code	Size	Price/Pack ₹
CH0525A <sup>1</sup>	12.5 x 12.5 cm	<b>880.00</b>
CH0525B <sup>2</sup>	15 x 15 cm	<b>990.00</b>



### Wire Gauze - Iron Plain

- Square wire gauze made of iron
- Pack of 10

Code	Size	Price/Pack ₹
CH0526A <sup>3</sup>	12.5 x 12.5 cm	<b>636.00</b>
CH0526B	15 x 15 cm	<b>697.00</b>

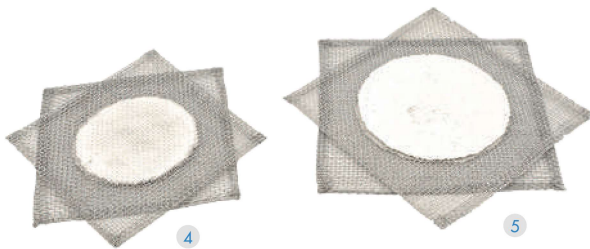

### Wire Gauze - Stainless Steel with Ceramic Center

- Square wire gauze made of stainless steel with ceramic center
- Pack of 10

Code	Size	Price/Pack ₹
CH0527A <sup>4</sup>	12.5 x 12.5 cm	<b>1558.00</b>
CH0527B <sup>5</sup>	15 x 15 cm	<b>1943.00</b>



### Wire Gauze - Stainless Steel Plain

- Square wire gauze made of stainless steel
- Pack of 10

Code	Size	Price/Pack ₹
CH0527C <sup>6</sup>	12.5 x 12.5 cm	<b>1301.00</b>
CH0527D	15 x 15 cm	<b>1638.00</b>

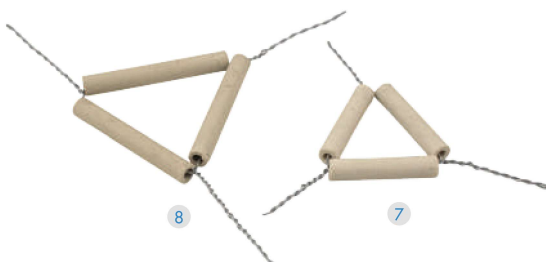

### Clay Pipe Triangle

- Clay pipes on thick iron wire
- Pack of 10

Code	Size	Price/Pack ₹
CH0530A <sup>7</sup>	5 cm	<b>550.00</b>
CH0530B	6 cm	<b>550.00</b>
CH0530C <sup>8</sup>	7.5 cm	<b>929.00</b>



### Spatula Spoon - Stainless Steel, Wide Handle

- Flat handle with one concave spoon end and one flat spatula end
- Made of polished stainless steel
- Pack of 10

Code	Specs	Price/Pack ₹
CH0632A <sup>1</sup>	Length - 12.5 cm	<b>489.00</b>
CH0632B	Length - 15 cm	<b>569.00</b>
CH0632C	Length - 20 cm	<b>782.00</b>



### Spatula - Stainless Steel, Wide Handle, Dual End

- Flat handle with two flat spatula ends
- Made of polished stainless steel
- Pack of 10

Code	Specs	Price/Pack ₹
CH0634C <sup>2</sup>	Length - 20 cm	<b>880.00</b>



### Scoop - Stainless Steel

- Semicircular cross section with one blunt end and one tapered end, 16 cm long
- Made of stainless steel
- Lacquered hardwood handle available separately (not pictured)
- Pack of 10

Code	Specs	Price/Pack ₹
CH0635A <sup>3</sup>	Spatula - Scoop Type	<b>929.00</b>
CH0635B	Spatula Handle - Each	<b>299.00</b>



### Micro Spatula Spoon - Stainless Steel

- 23 cm long with one concave spoon end and one flat spatula end (30 x 8 mm)
- Handle diameter 4 mm
- Made of stainless steel
- Pack of 10

Code	Specs	Price/Pack ₹
CH0635C <sup>4</sup>	Length - 23 cm	<b>2053.00</b>



### Micro Spatula Scoop - Stainless Steel

- 15 cm long with one concave scoop end and one flat spatula end
- Handle diameter 2 mm
- Made of stainless steel
- Pack of 10

Code	Specs	Price/Pack ₹
CH0635D <sup>5</sup>	Length - 15 cm	<b>604.00</b>





### Semi Micro Arrowhead Spatula - Stainless Steel Dual End

- 20 cm long with one flat blunt end and one flat tapered end
- Handle diameter 4 mm
- Made of stainless steel
- Pack of 10

Code	Specs	Price/Pack ₹
CH0635E <sup>1</sup>	Length - 20 cm	<b>1124.00</b>



### Chattaway Spatula

- Traditional Chattaway spatula with one flat blunt end
- One rounded end with bent tip
- Made of polished stainless steel
- Pack of 10

Code	Specs	Price/Pack ₹
CH0636A	Length - 15 cm	<b>758.00</b>
CH0636B	Length - 20 cm	<b>831.00</b>
CH0636C <sup>2</sup>	Length - 10 cm	<b>721.00</b>



### Trowel Scoop - Stainless Steel, Dual End

- 17.5 cm long with two trowel shaped ends
- Larger is 22 mm wide and the smaller is 11 mm wide
- Made of stainless steel
- Pack of 10

Code	Specs	Price/Pack ₹
CH0639 <sup>3</sup>	Length - 17.5 cm	<b>1051.00</b>



### Palette Knife Spatula

- Flat, flexible metal blade with wooden handle
- Pack of 10

Code	Specs	Price/Pack ₹
CH0640 <sup>4</sup>	Palette Knife Spatula - 15 cm	<b>2396.00</b>
CH0640B	Palette Knife Spatula - 10 cm	<b>2166.00</b>
CH0640C	Palette Knife Spatula - 20 cm	<b>3180.00</b>



### Spatula & Scoops - Teflon Coated

- The Teflon coating is non-stick and resistant to most chemicals
- Items sold separately

Code	Specs	Price/Piece ₹
CH0632ATFC <sup>5</sup>	Spatula spoon, wide handle - 15 cm long	<b>232.00</b>
CH0634TFC	Spatula, wide handle, dual end - 15 cm long	<b>232.00</b>
CH0635TFC <sup>6</sup>	Micro spatula spoon - 23 cm long	<b>323.00</b>
CH0635ATFC	Scoop	<b>232.00</b>
CH0635ETFC	Semi micro arrowhead spatula, dual end - 20 cm long	<b>287.00</b>
CH0636ATFC	Chattaway spatula - 15 cm long	<b>232.00</b>
CH0636BTFC	Chattaway spatula - 20 cm long	<b>262.00</b>
CH0637TFC <sup>7</sup>	Nuffeild spatula	<b>232.00</b>



### Burette Clamps

- Spring loaded jaws made from high strength zinc die-cast alloy with non-toxic powdered coating
- Suitable for all burettes up to 100 ml
- Bosshead accommodates rods up to 16 mm dia

Code	Specs	Price/Piece ₹
CH0258A 1	Burette Clamp - Single	699.00
CH0258B 2	Burette Clamp - Double	947.00



### Burette Clamps - Economy

- 3 prong vinyl coated clamp with in built bosshead suitable for all burettes up to 100 ml
- Made from die-cast metal
- Bosshead accommodates rods up to 16 mm dia

Code	Specs	Price/Piece ₹
CH0256A 3	Burette Clamp - Single	419.00
CH0256B 4	Burette Clamp - Double	589.00



### Double Burette Clamp Support Stand with Rod

- This burette clamp with alloy jaws is suitable for all burettes upto 100 ml
- Supplied with a cast iron blue base
- Base is 7" wide X 13" long, weight 3 kg
- Stainless steel rod with dia 12 mm & length 60 cm

Code	Specs	Price/Piece ₹
CH2019004 5	Double Burette Clamp Support Stand with Rod	4950.00



### Laboratory Jacks - Standard

- Light weight steel construction with a screw operated mechanism that allows smooth, easy height adjustment

Code	Dimensions	Max. Opening Height	Top Plate	Weight	Max. Static Load	Price/Piece ₹
CH0642A 6	15x13x6 cm	23.5 cm	13x15 cm	1.6 kg	2 kg	4400.00
CH0642B 7	20x20x7cm	30 cm	20x20 cm	3 kg	4 kg	5176.00





## EISCO PREMIUM LABORATORY JACKS

- Corrosion-resistant stainless steel
- Rugged construction
- Fast and easy adjustment
- Improved lift mechanism provides increased stability and torsional rigidity
- Precise height adjustment with a twist of the knob
- Gas springs to support loads
- Stainless steel mirror surface finish is easy to clean & sanitize
- Exceptional stability and durability
- Available in a range of sizes and load capacities





## Eisco Premium Laboratory Jacks - Stainless Steel

Code	Dimensions	Max. Open Height	Top Plate	Weight	Max. Static Load	Price/Piece ₹
SSJCT10	14.5 x 7.5 x 4.5 cm	15 cm	8 x 7.3 cm	0.6 kg	3 kg	<b>11978.00</b>
SSJCT20	23.5 x 13 x 6.5 cm	28 cm	16.5 x 13 cm	1.9 kg	5 kg	<b>15278.00</b>
SSJCT30	25 x 20 x 7 cm	28 cm	20 x 20 cm	2.6 kg	5 kg	<b>16500.00</b>
SSJCT40	25 x 30 x 6 cm	33 cm	25 x 25 cm	3.6 kg	5 kg	<b>39111.00</b>
SSJCT50	35 x 30 x 8 cm	48 cm	30 x 30 cm	9.8 kg	12 kg	<b>91667.00</b>
SSJCT60	45 x 30 x 8 cm	50 cm	40 x 40 cm	15 kg	15 kg	<b>103889.00</b>



### Tripod Stand - Triangular

- Triangular tripod stands are 20 cm tall
- Length of each side is 12.5 cm
- For use with spirit lamps (not included)

Code	Specs	Price/Piece ₹
CH0646A 1	Tripod Stand - Stainless Steel	660.00
CH0646B 2	Tripod Stand - Iron	437.00



### Retort Stand Bases - Triangular 3

- Black cast iron base with three points for stability
- Tapped hole with 10 x 1.5 mm thread

Code	Specs	Radius	Weight	Price/Piece ₹
CH0648A	Medium	100 mm	800 g	1149.00
CH0648B	Large	130 mm	1000 g	1521.00
CH0648C	Extra Large	160 mm	1500 g	1699.00



### Deluxe Retort Stand Bases - Sheet Metal 4

- Pressed steel base, tapped hole with 10 x 1.5 mm thread in center of one short side
- Finished with chemical resistant blue paint & fitted with rubber feet

Code	Length	Width	Weight	Price/Piece ₹
CH0649A	16 cm	10 cm	750 g	758.00
CH0649B	20 cm	12.5 cm	1200 g	1051.00
CH0649C	25 cm	16 cm	1800 g	1442.00
CH0649D	30 cm	20 cm	2850 g	2279.00



### Rectangular Retort Stand Base - Stainless Steel

- Made of high quality stainless steel
- Corrosion resistant mirror surface finish
- Adjustable leveling screw
- Feature 10 x 1.5 threaded hole to accommodate various attachments

Code	Sizes	Price/Piece ₹
CH0654ASS 5	21 X 13 cm	2672.00
CH0654BSS	25 X 16 cm	3190.00
CH0654CSS 6	30 X 15 cm	3879.00



### 'A' Shape Retort Stand Bases - Cast Iron Nesting

- 'A' shape cast iron base, tapped hole with 10 x 1.5 mm thread in center
- Finished with chemical resistant powder coat
- Bases can nest in one another for compact storage

Code	Side	Weight	Price/Piece ₹
CH0655E	18 cm	0.95 kg	<b>1068.00</b>
CH0655F <sup>1</sup>	22 cm	1.50 kg	<b>1457.00</b>
CH0655G	28 cm	2.50 kg	<b>2200.00</b>



### Burette Support Stand - Cast Iron

- Heavy duty cast iron base designed for use with a double burette holder (not included)
- Tapered hole with 10 x 1.5 mm thread in center of one long side
- Finished with chemical resistant blue paint

Code	Length	Width	Weight	Price/Piece ₹
CH0656A <sup>2</sup>	13 cm	7 cm	3 kg	<b>2998.00</b>



### Steel Rods <sup>3</sup>

- Made of high quality steel
- Threaded end (10 x 1.5 mm) fits in all Eisco bases

Code	Length	Dia.	Price/Piece ₹
CH0657A	50 cm	12 mm	<b>421.00</b>
CH0657B	60 cm	12 mm	<b>466.00</b>
CH0657C	75 cm	12 mm	<b>672.00</b>
CH0657D	100 cm	12 mm	<b>948.00</b>



### Retort Stand Sets - Value

- Includes a pressed steel base with 10 x 1.5 mm threaded hole in the center of one short side
- Steel rod with 10 x 1.5 mm thread
- Base finished with chemical resistant blue paint

Code	Base	Rod length	Rod Dia.	Price/Set ₹
STDRD <sup>4</sup>	12.5 x 20 cm	60 cm	12 mm	<b>1416.00</b>
STDRDVL02	10 x 16 cm	50 cm	12 mm	<b>1121.00</b>
STDRDVL03	16 x 25 cm	75 cm	12 mm	<b>1929.00</b>



### Retort Stand Sets - Cast Iron

- Includes a cast iron base with 10 x 1.5 mm threaded hole in the center of one short side
- Steel rod with 10 x 1.5 mm thread
- Base finished with chemical resistant blue paint

Code	Base	Rod length	Rod Dia.	Price/Set ₹
CH0653ARD1 <sup>5</sup>	10 x 16 cm	50 cm	11 mm	<b>1436.00</b>
CH0653BRD2	12.5 x 20 cm	50 cm	11 mm	<b>1894.00</b>
CH0653D1RD3	16 x 23 cm	60 cm	11 mm	<b>2053.00</b>
CH0653E1RD4	16 x 28 cm	90 cm	12.5 mm	<b>3202.00</b>





### Retort Stand Sets - Stainless Steel

- Includes stainless steel base with 10 x 1.5 mm threaded hole
- Stainless steel rod with 10 x 1.5 mm thread
- Base fitted with adjustable levelling screw
- Complete non-ferrous construction

Code	Base	Rod Length	Rod Dia.	Price/Set ₹
CH0654ASSRD1 ①	21 X 13 cm	60 cm	12 cm	<b>3911.00</b>
CH0654BSSRD2	25 X 16 cm	60 cm	12 cm	<b>4644.00</b>
CH0654BSSRD3	25 X 16 cm	75 cm	12 cm	<b>5133.00</b>
CH0654CSSRD4 ②	30 X 15 cm	100 cm	12 cm	<b>8311.00</b>

### Retort Stand Sets - Double Thread

- Includes heavy pressed base with two tapped hole with 10 x 1.5 mm thread
- One tapped hole in center of short side, other in center of base
- Base finished in blue colour and fitted with rubber feet
- Steel rods with 10 x 1.5 mm thread

Code	Base	Rod length	Rod Dia.	Price/Set ₹
STDRD1DTH ③	12.5 X 20 cm	60 cm	12 mm	<b>1638.00</b>
STDRDSP02DTH ④	10 X 16 cm	50 cm	12 mm	<b>1292.00</b>
STDRDSP03DTH	16 X 25 cm	75 cm	12 mm	<b>2279.00</b>

### 'A' Shaped Retort Stand Sets

- Included cast iron A-shaped base with 10 x 1.5 mm threaded base
- Steel rod with 10 x 1.5 mm thread
- Base finished with chemical resistant blue paint

Code	Base	Rod length	Rod Dia.	Price/Set ₹
STDRDAB01	'A' base, side 18 cm	50 cm	12 mm	<b>1784.00</b>
STDRDAB02	'A' base, side 22 cm	60 cm	12 mm	<b>2157.00</b>
STDRDAB03 ⑤	'A' base, side 28 cm	75 cm	12 mm	<b>3086.00</b>



Come chat with us  
Live on [www.eiscoindustrial.in](http://www.eiscoindustrial.in)



### Closed Support Rings 1

- Closed ring made of plated mild steel

Code	I.D. of Ring	Length of Stem	Price/Piece ₹
CH0668A	5 cm	14 cm	<b>220.00</b>
CH0668B	7.5 cm	14 cm	<b>244.00</b>
CH0668C	10 cm	14 cm	<b>278.00</b>
CH0668D	15 cm	14 cm	<b>323.00</b>



Check out even more Products  
[www.eiscoindustrial.com](http://www.eiscoindustrial.com)

### Closed Support Rings with Bossheads 2

- Stainless steel ring with integrated stem
- Bosshead fitted with thumb screw
- Accepts rods upto 16 mm in diameter
- 14 cm from center of support to center of ring

Code	Inner Dia.	Price/Piece ₹
CH0672ASS	5 cm	<b>352.00</b>
CH0672BSS	7.5 cm	<b>372.00</b>
CH0672CSS	10 cm	<b>440.00</b>



### Closed Support Rings with Bossheads - Zinc Plated 3

- Zinc plated cast iron ring with integrated stem
- Distance is 12 cm from center of support to center of the ring
- Fitted with thumb screws
- Accepts rods upto 16 mm in diameter

Code	Inner Dia.	Price/Piece ₹
CH0674A	5 cm	<b>477.00</b>
CH0674B	7.5 cm	<b>538.00</b>
CH0674C	10 cm	<b>587.00</b>
CH0674D	12.5 cm	<b>660.00</b>
CH0674E	15 cm	<b>714.00</b>





# EISCO PREMIUM TONGS & HOLDERS

- Research grade quality for academic, research and industrial applications
- Made of high quality 304 grade stainless steel
- Rust and corrosion resistant

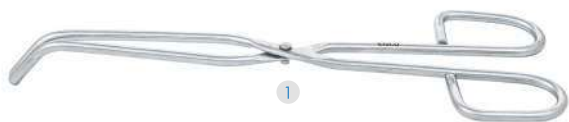

### Crucible Tongs - Straight, Stainless Steel

- 304 grade stainless steel straight crucible tongs
- Flat hinge

Code	Specs	Price/Piece ₹
CH0734ESUP	15 cm	<b>296.00</b>
CH0734FSUP 1	20 cm	<b>430.00</b>
CH0732A	30 cm	<b>684.00</b>

### Premium Crucible Tongs - Stainless Steel, with Bow

- 304 grade stainless steel crucible tongs with looped handles
- Bowed jaws with flat ends

Code	Specs	Price/Piece ₹
CH0735ESUP	15 cm	<b>308.00</b>
CH0735FSUP 2	20 cm	<b>456.00</b>
CH0732B	30 cm	<b>684.00</b>
CH0732C	40 cm	<b>824.00</b>

### Beaker Tongs - Standard

- For handling beakers from 50 to 2000 ml capacity
- Made of nickelplated steel wire
- Overall length 23 cm
- Maximum jaw opening is 15 cm
- PVC coated jaws

Code	Specs	Price/Piece ₹
BKTG 3	Beaker Tongs	<b>470.00</b>
BKTGSS	Beaker Tongs - Stainless Steel	<b>723.00</b>

### Premium Test Tube Clamp - Stainless Steel

- 304 grade stainless steel test tube clamp
- Accepts all test tubes sizes
- 13 cm length

Code	Specs	Price/Piece ₹
CH0730CSUP 4	Premium Test Tube Clamp - Stainless Steel, 13 cm	<b>156.00</b>





### Test Tube Holder - Vinyl coated

- Stainless steel test tube holder with strong spring clip and wooden handle
- Accepts 15-25 mm test tubes

Code	Specs	Price/Piece ₹
CH0728B <sup>1</sup>	Test Tube Holder - Stainless Steel	<b>391.00</b>



### Test Tube Stand - 'Z' Shape <sup>2</sup>

'Z' shape, made from 18 gauge aluminium sheet, powder coated and 3 tier. With 5 holes of 23 mm dia., 6 holes of 20 mm dia. and 8 holes of 13 mm dia. Overall height of 75 mm and length of 200 mm.

Code	Specs	Price/Piece ₹
CH0713A	Test Tube Stand - 'Z' shape	<b>577.00</b>
CH0713B	Test Tube Stand - 'Z' shape (17 mm x 25 holes)	<b>577.00</b>
CH0713C	Test Tube Stand - 'Z' shape (17 mm x 50 holes)	<b>758.00</b>



### Test Tube Rack - Epoxy Coated Steel Wire, 20 Tubes

- Epoxy-coated, steel wire test tube rack
- Resists most solvents, weak acids & bases
- Withstands temperatures up to 121°C
- Holds up to 20 test tubes (18-20 mm dia.)
- 4 x 5 row configuration
- Pack of 5

Code	Specs	Price/Pack ₹
CH182015A <sup>3</sup>	Epoxy Coated Steel Wire, 20 Tubes	<b>13750.00</b>



### Test Tube Rack - Epoxy Coated Steel Wire, 24 Tubes

- Epoxy-coated, steel wire test tube rack
- Resists most solvents, weak acids & bases
- Withstands temperatures up to 121°C
- Holds up to 24 test tubes (15-16 mm dia.)
- 4 x 6 row configuration
- Pack of 5

Code	Specs	Price/Pack ₹
CH182015B <sup>4</sup>	Epoxy Coated Steel Wire, 24 Tubes	<b>16256.00</b>





**Test Tube Rack - Epoxy Coated Steel Wire, 40 Tubes**

- Epoxy-coated, steel wire test tube rack
- Resists most solvents, weak acids & bases
- Withstands temperatures up to 121°C
- Holds up to 40 test tubes (18-20 mm dia.)
- 4 x 10 row configuration
- Pack of 5

Code	Specs	Price/Pack ₹
CH182015C 1	Epoxy Coated Steel Wire, 40 Tubes	26889.00

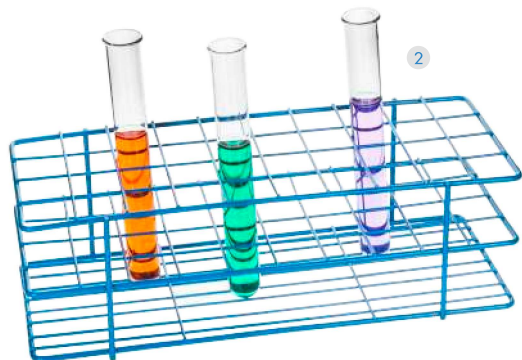

**Test Tube Rack - Epoxy Coated Steel Wire, 40 Tubes**

- Epoxy-coated, steel wire test tube rack
- Resists most solvents, weak acids & bases
- Withstands temperatures up to 121°C
- Holds up to 40 test tubes (20-22 mm dia.)
- 4 x 10 row configuration
- Pack of 5

Code	Specs	Price/Pack ₹
CH182015D 2	Epoxy Coated Steel Wire, 40 Tubes	26889.00



**Test Tube Rack - Epoxy Coated Steel Wire, 36 Tubes**

- Epoxy-coated, steel wire test tube rack
- Resists most solvents, weak acids & bases
- Withstands temperatures up to 121°C
- Holds up to 36 test tubes (10-13 mm dia.)
- 6 x 6 row configuration
- Pack of 5

Code	Specs	Price/Pack ₹
CH182015E 3	Epoxy Coated Steel Wire, 36 Tubes	16036.00



**Test Tube Rack - Epoxy Coated Steel Wire, 72 Tubes**

- Epoxy-coated, steel wire test tube rack
- Resists most solvents, weak acids & bases
- Withstands temperatures up to 121°C
- Holds up to 72 test tubes (15-16 mm dia.)
- 6 x 12 row configuration
- Pack of 5

Code	Specs	Price/Pack ₹
CH182015F 4	Epoxy Coated Steel Wire, 72 Tubes	26889.00



### Test Tube Rack - Epoxy Coated Steel Wire, 80 Tubes

- Epoxy-coated, steel wire test tube rack
- Resists most solvents, weak acids & bases
- Withstands temperatures up to 121°C
- Holds up to 80 test tubes (18-20 mm dia.)
- 8 x 10 row configuration
- Pack of 5

Code	Specs	Price/Pack ₹
CH182015G ①	Epoxy Coated Steel Wire, 80 Tubes	28417.00



①

### Test Tube Rack - Epoxy Coated Steel Wire, 80 Tubes

- Epoxy-coated, steel wire test tube rack
- Resists most solvents, weak acids & bases
- Withstands temperatures up to 121°C
- Holds up to 80 test tubes (22-25 mm dia.)
- 8 x 10 row configuration
- Pack of 5

Code	Specs	Price/Pack ₹
CH182015H ②	Epoxy Coated Steel Wire, 80 Tubes	30250.00

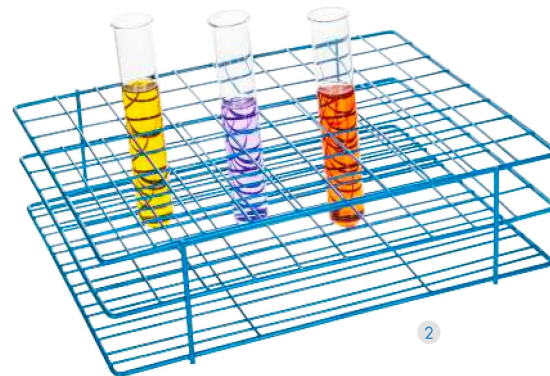

②

### Test Tube Rack - Epoxy Coated Steel Wire, 90 Tubes

- Epoxy-coated, steel wire test tube rack
- Resists most solvents, weak acids & bases
- Withstands temperatures up to 121°C
- Holds up to 90 test tubes (10-12 mm dia.)
- 6 x 15 row configuration
- Pack of 5

Code	Specs	Price/Pack ₹
CH182015I ③	Epoxy Coated Steel Wire, 90 Tubes	31167.00

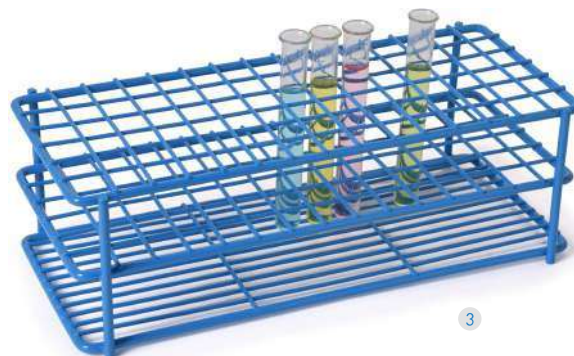

③

### Test Tube Rack - Epoxy Coated Steel Wire, 72 Tubes

- Epoxy-coated, steel wire test tube rack
- Resists most solvents, weak acids & bases
- Withstands temperatures up to 121°C
- Holds up to 72 test tubes (16-18 mm dia.)
- 6 x 12 row configuration
- Pack of 5

Code	Specs	Price/Pack ₹
CH182015J ④	Epoxy Coated Steel Wire, 72 Tubes	30250.00

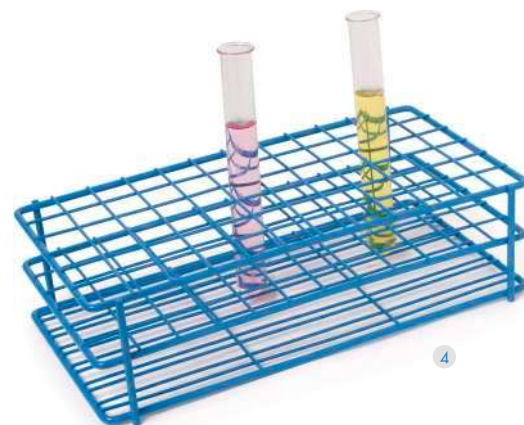

④